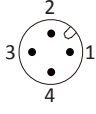

M18 LOW TEMPERATURE SERIES

ARTICLE PROPERTIES

SENSOR TYPE	Inductive sensor	CONNECTION TYPES (<i>see table</i>)
SIZE	M18x1	<ul style="list-style-type: none"> • cable PVC, 0.34 mm², 2 m** • M12 connector, A-coded
RATED OPERATING DISTANCE	<i>see table</i>	
NUMBER OF CONDUCTORS	2-wire / 3-wire (<i>see table</i>)	

** other cable lengths are available on request

MECHANICAL DATA

MOUNTING (mounting nuts included in delivery)	flush/non-flush (<i>see table</i>)
HOUSING	threaded cylindrical
MATERIAL HOUSING	brass nickel-plated
MATERIAL SENSING SURFACE	PBT
TIGHTENING TORQUE LOCKING	20 Nm
STANDARD TEST	FE360
ATTENUATION COEFFICIENT	St37 = 1, V2A = 0.7, Al = 0.3

ELECTRICAL DATA

OPERATING VOLTAGE	DC: 10 ... 30 V DC AC/DC: 20 ... 250 V AC/DC
RATED OPERATING CURRENT	2-wire: ≤ 100 mA 2-wire AC: ≤ 200 mA 3-wire: ≤ 200 mA
SWITCHING FREQUENCY	<i>see table</i>
SWITCHING OUTPUT	<i>see table</i>
FUNCTION INDICATOR	yellow LED
HYSTERESIS	3 ... 15 %
TEMPERATURE DRIFT	±10 %
SHORT-CIRCUIT PROTECTION	yes
OVERLOAD RESISTANCE	yes
REVERSE POLARITY PROTECTION	yes

ENVIRONMENTAL CONDITIONS

PROTECTION CLASS	IP67	VIBRATION RESISTANCE (EN 60068-2-27)	55 Hz, 1 mm
AMBIENT TEMPERATURE	-40 ... 70 °C	SHOCK RESISTANCE (EN 60068-2-6)	30g/11 ms

STANDARDS AND DIRECTIVES

LOW-VOLTAGE SWITCHGEAR AND CONTROLGEAR	DIN EN IEC 60947-5-2:2021-04
---	------------------------------

APPROVALS



M18 LOW TEMPERATURE SERIES

DC 2-WIRE OUTPUT CABLE

Article number	Mounting	Rated operating distance Sn	Switching output (wiring diagram)	Switching frequency	Dimensions
Fi5-M18-OD6L/TB40	flush	5 mm	DC NO (WD1)	800 Hz	see Fig. 1
Fi5-M18-CD6L/TB40	flush	5 mm	DC NC (WD2)	800 Hz	see Fig. 1
Ni8-M18-OD6L/TB40	non-flush	8 mm	DC NO (WD1)	500 Hz	see Fig. 2
Ni8-M18-CD6L/TB40	non-flush	8 mm	DC NC (WD2)	500 Hz	see Fig. 2

DC 2-WIRE OUTPUT M12 CONNECTOR

Article number	Mounting	Rated operating distance Sn	Switching output (wiring diagram)	Switching frequency	Dimensions
Fi5-M18-OD6L-Q12/TB40	flush	5 mm	DC NO (WD1)	800 Hz	see Fig. 6
Fi5-M18-CD6L-Q12/TB40	flush	5 mm	DC NC (WD2)	800 Hz	see Fig. 6
Ni8-M18-OD6L-Q12/TB40	non-flush	8 mm	DC NO (WD1)	500 Hz	see Fig. 7
Ni8-M18-CD6L-Q12/TB40	non-flush	8 mm	DC NC (WD2)	500 Hz	see Fig. 7

AC/DC 2-WIRE OUTPUT CABLE

Article number	Mounting	Rated operating distance Sn	Switching output (wiring diagram)	Switching frequency	Dimensions
Fi5-M18-OA41L/TB40	flush	5 mm	AC/DC NO (WD5)	40 Hz	see Fig. 4
Fi5-M18-CA41L/TB40	flush	5 mm	AC/DC NC (WD6)	40 Hz	see Fig. 4
Ni8-M18-OA41L/TB40	non-flush	8 mm	AC/DC NO (WD5)	40 Hz	see Fig. 5
Ni8-M18-CA41L/TB40	non-flush	8 mm	AC/DC NC (WD6)	40 Hz	see Fig. 5

AC/DC 2-WIRE OUTPUT M12 CONNECTOR

Article number	Mounting	Rated operating distance Sn	Switching output (wiring diagram)	Switching frequency	Dimensions
Fi5-M18-OA41L-Q12/TB40	flush	5 mm	AC/DC NO (WD5)	40 Hz	see Fig. 8
Fi5-M18-CA41L-Q12/TB40	flush	5 mm	AC/DC NC (WD6)	40 Hz	see Fig. 8
Ni8-M18-OA41L-Q12/TB40	non-flush	8 mm	AC/DC NO (WD5)	40 Hz	see Fig. 9
Ni8-M18-CA41L-Q12/TB40	non-flush	8 mm	AC/DC NC (WD6)	40 Hz	see Fig. 9

M18 LOW TEMPERATURE SERIES

DC 3-WIRE OUTPUT CABLE

Article number	Mounting	Rated operating distance Sn	Switching output (wiring diagram)	Switching frequency	Dimensions
Fi5-M18-OP6L/TB40	flush	5 mm	PNP NO (WD7)	800 Hz	see Fig. 1
Fi5-M18-ON6L/TB40	flush	5 mm	NPN NO (WD8)	800 Hz	see Fig. 1
Fi5-M18-CP6L/TB40	flush	5 mm	PNP NC (WD9)	800 Hz	see Fig. 1
Fi5-M18-CN6L/TB40	flush	5 mm	NPN NC (WD10)	800 Hz	see Fig. 1
Ni8-M18-OP6L/TB40	non-flush	8 mm	PNP NO (WD7)	500 Hz	see Fig. 3
Ni8-M18-ON6L/TB40	non-flush	8 mm	NPN NO (WD8)	500 Hz	see Fig. 3
Ni8-M18-CP6L/TB40	non-flush	8 mm	PNP NC (WD9)	500 Hz	see Fig. 3
Ni8-M18-CN6L/TB40	non-flush	8 mm	NPN NC (WD10)	500 Hz	see Fig. 3

DC 3-WIRE OUTPUT M12 CONNECTOR

Article number	Mounting	Rated operating distance Sn	Switching output (wiring diagram)	Switching frequency	Dimensions
Fi5-M18-OP6L-Q12/TB40	flush	5 mm	PNP NO (WD7)	800 Hz	see Fig. 6
Fi5-M18-ON6L-Q12/TB40	flush	5 mm	NPN NO (WD8)	800 Hz	see Fig. 6
Fi5-M18-CP6L-Q12/TB40	flush	5 mm	PNP NC (WD9)	800 Hz	see Fig. 6
Fi5-M18-CN6L-Q12/TB40	flush	5 mm	NPN NC (WD10)	800 Hz	see Fig. 6
Ni8-M18-OP6L-Q12/TB40	non-flush	8 mm	PNP NO (WD7)	500 Hz	see Fig. 7
Ni8-M18-ON6L-Q12/TB40	non-flush	8 mm	NPN NO (WD8)	500 Hz	see Fig. 7
Ni8-M18-CP6L-Q12/TB40	non-flush	8 mm	PNP NC (WD9)	500 Hz	see Fig. 7
Ni8-M18-CN6L-Q12/TB40	non-flush	8 mm	NPN NC (WD10)	500 Hz	see Fig. 7

M18 LOW TEMPERATURE SERIES

DIMENSIONS

Fig. 1 Inductive sensor with cable (flush)

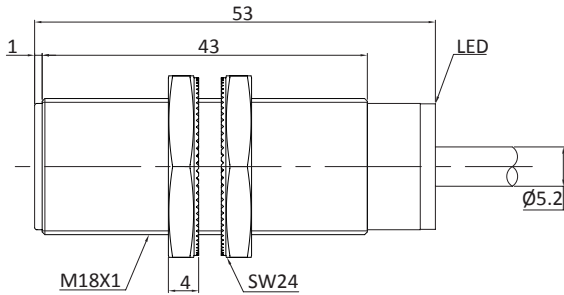

Fig. 2 Inductive sensor with cable (non-flush)

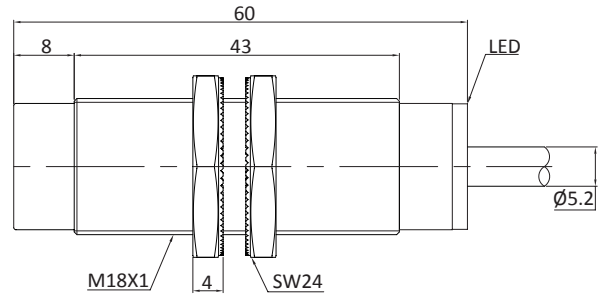

Fig. 3 Inductive sensor with cable (non-flush)

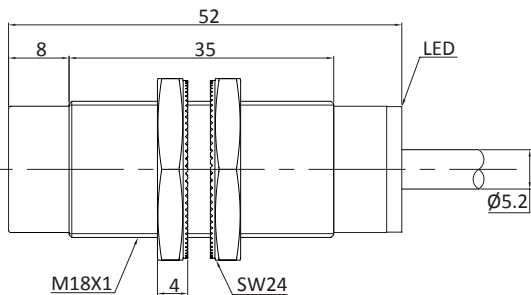

Fig. 4 Inductive sensor with cable (flush)

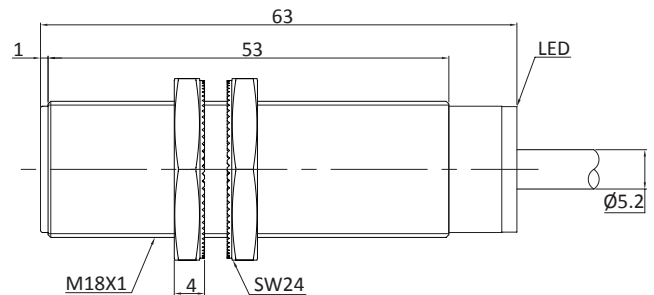

Fig. 5 Inductive sensor with cable (non-flush)

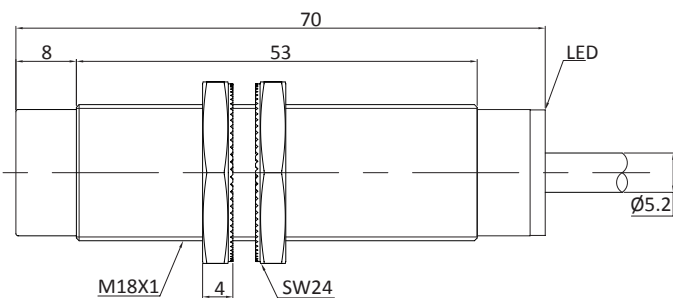

Fig. 6 Inductive sensor with M12 connector (flush)

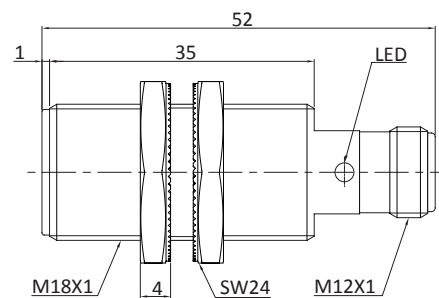

Fig. 7 Inductive sensor with M12 connector (non-flush)

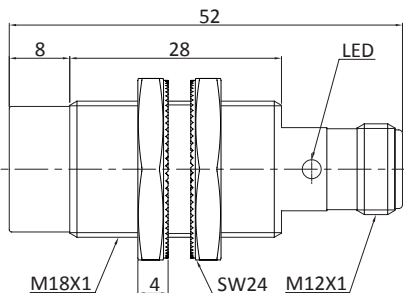
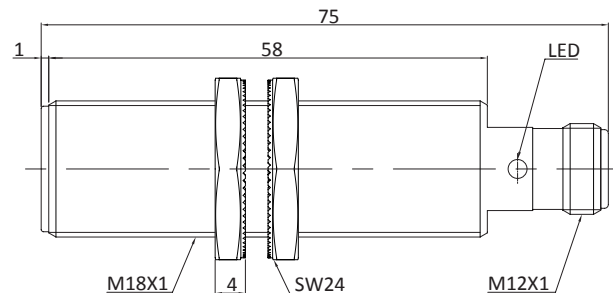

Fig. 8 Inductive sensor with M12 connector (flush)



The information contained in this data sheet was compiled with the greatest possible care. Liability for correctness, completeness and topicality is limited to gross negligence.

M18 LOW TEMPERATURE SERIES

DIMENSIONS

Fig. 9 Inductive sensor with M12 connector (non-flush)

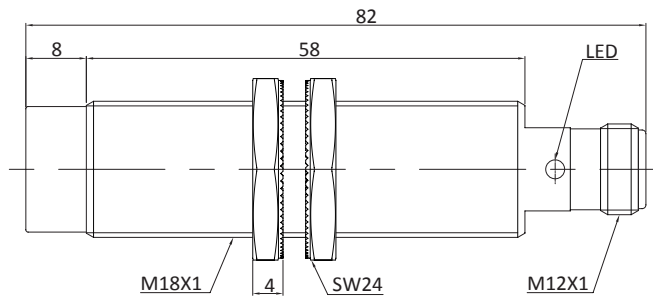

M18 LOW TEMPERATURE SERIES

WIRING DIAGRAMS (Note: 1 / 2 / 3 / 4 connector and terminals pin number Bn / Bu / Wh / Bk cable color)

WD1 DC 2-wire NO

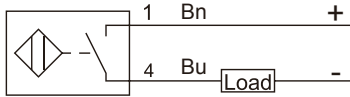

WD2 DC 2-wire NC

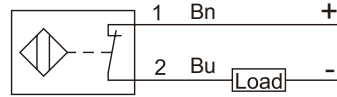

WD3 AC 2-wire NO

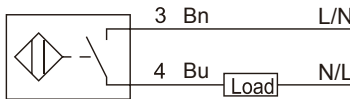

WD4 AC 2-wire NC

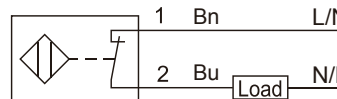

WD5 AC / DC 2-wire NO

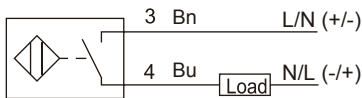

WD6 AC / DC 2-wire NC

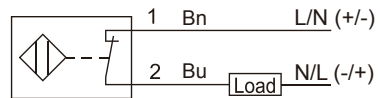

WD7 DC 3-wire PNP NO

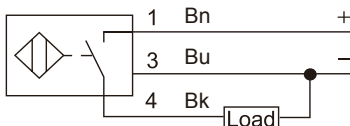

WD8 DC 3-wire NPN NO

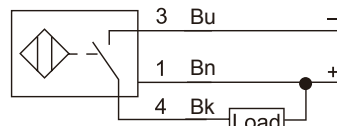

WD9 DC 3-wire PNP NC

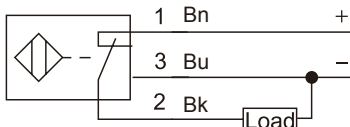

WD10 DC 3-wire NPN NC

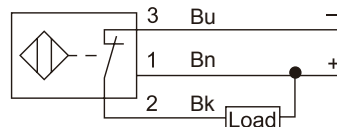

WD11 DC 4-wire PNP NO + NC

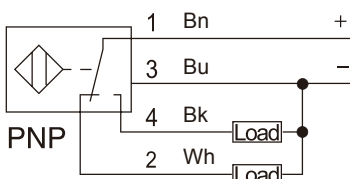

WD12 DC 4-wire NPN NO + NC

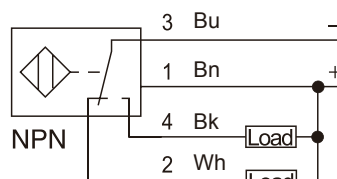

The information contained in this data sheet was compiled with the greatest possible care. Liability for correctness, completeness and topicality is limited to gross negligence.

M18 LOW TEMPERATURE SERIES

WIRING DIAGRAMS (Note: 1 / 2 / 3 / 4 connector and terminals pin number Bn / Bu / Wh / Bk cable color)

WD13 AC/DC 4-wire NO+NC

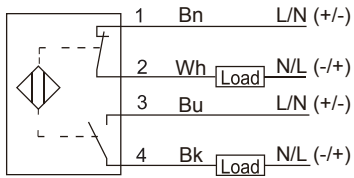

WD14 NAMUR 2-wire NC

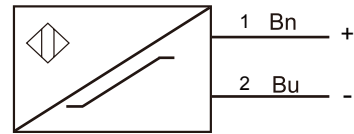

WD15 DC 4-wire 0-10V+0-20mA

